

## N20010, N34010

### NON-SPRING RETURN DIRECT-COUPLED DAMPER ACTUATORS FOR MODULATING AND FLOATING / 2-POSITION CONTROL

#### PRODUCT DATA



#### GENERAL

These direct-coupled damper actuators provide modulating control for:

- air dampers,
- VAV units,
- air handling units,
- ventilation flaps,
- louvers, and
- reliable control for air damper applications with up to 4.6 m<sup>2</sup> / 50 sq.ft. (20 Nm / 177 lb-in) or 7.8 m<sup>2</sup> / 85 sq. ft. (34 Nm / 300 lb-in) (seal-less dampers; air friction-dependent).

#### FEATURES

- **Self-centering shaft adapter**
- **Access cover to facilitate connectivity**
- **Service/off for safe and easy servicing**
- **Rotation direction selectable by switch**
- **Declutch for manual adjustment**
- **Mechanical end limits**
- **Field-installable auxiliary switches (optional)**
- **Mountable in any orientation (no IP54 if upside down)**
- **Mechanical position indicator**
- **CE and UL-certified**

#### SPECIFICATIONS

|   |  |
|---|--|
| <b>Supply voltage</b>   | 24 Vac/dc ±15%, 50/60 Hz                         |
| <b>Nominal voltage</b>  | 24 Vac/dc, 50/60 Hz                              |
| <i>All values stated hereinafter apply to operation under nominal voltage conditions.</i> |  |
| <b>Power consumption</b>  |  |
| N20010  | 6 VA / 3 W                                       |
| N34010  | 6 VA / 3 W                                       |
| <b>Ambient limits</b>   |  |
| Ambient operating limits  | -20...+60 °C (-5...+140 °F)                      |
| Ambient storage limits  | -40...+80 °C (-40...+175 °F)                     |
| Relative humidity   | 5...95%, non-condensing                          |
| <b>Safety</b>   |  |
| Protection standard   | IP54 as per EN 60529                             |
| Protection class  | II as per EN 60730-1                             |
| Overvoltage category  | II   |
| <b>Lifetime</b>   |  |
| Full strokes  | 60000  |
| Repositions   | 1.5 million                                      |
| <b>Mounting</b>   |  |
| Round damper shaft  | 10...27 mm (3/8...1-1/16")                       |
| Square damper shaft   | 10...18 mm (3/8...11/16");<br>45° steps          |
| Shaft length  | min. 22 mm (7/8")                                |
| <b>Control signal</b>   |  |
|   | 0(2)...10 Vdc                                    |
|   | 0(4)...20 mA                                     |
| Input impedance   | >100 kΩ [0...10 V]<br>500 Ω [0...20 mA]          |
| <b>Feedback signal</b>  |  |
| Limits  | ± 1 mA at 0...10 V                               |
| <b>Internal end switches (when included)</b>  |  |
| Rating  | 5 A (resistive) / 3 A (inductive)                |
| Triggering points   | 5° / 85°   |
| <b>Torque rating</b>  |  |
| N20010  | 20 Nm (177 lb-in)                                |
| N34010  | 34 Nm (300 lb-in)                                |
| <b>Runtime</b>  | 95 sec (60 Hz) / 110 sec (50 Hz<br>or DC supply) |
| <b>Rotation stroke</b>  | 95° ± 3°   |
| <b>Dimensions</b>   | see "Dimensions" on pg. 8                        |
| <b>Weight (without cables)</b>  | 1.35 kg (3 lbs.)                                 |
| <b>CE and UL Certification</b>  | N20010, N20010-SW2, N34010                       |

## MODELS

| order number | internal end switches | control signal         | feedback   | torque            |
|--------------|-----------------------|------------------------|------------|-------------------|
| N20010       | --                    | 0...10 Vdc / 0...20 mA | 0...10 Vdc | 20 Nm (177 lb-in) |
| N20010-SW2   | 2                     | 0...10 Vdc / 0...20 mA | 0...10 Vdc | 20 Nm (177 lb-in) |
| N34010       | --                    | 0...10 Vdc / 0...20 mA | 0...10 Vdc | 34 Nm (300 lb-in) |

## Product Identification System

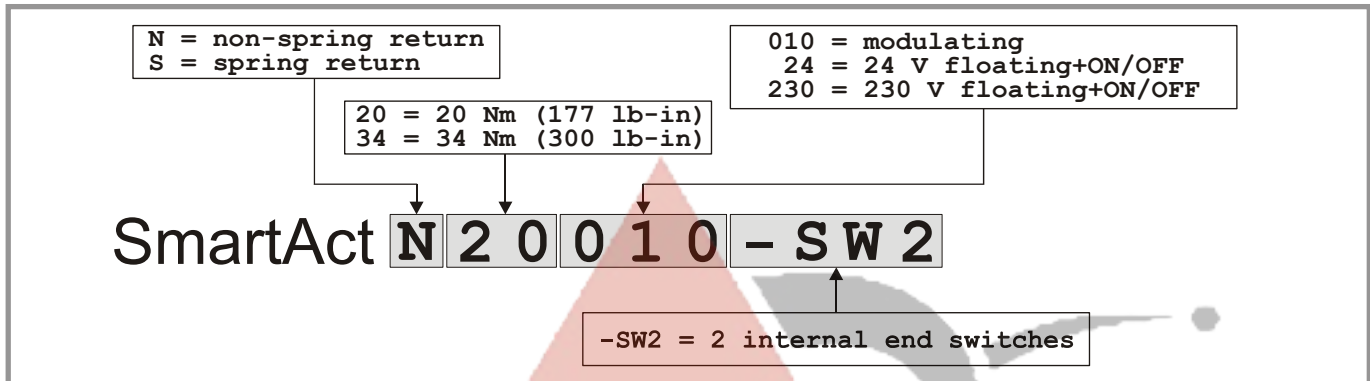

Fig. 1. Product Identification System

## OPERATION / FUNCTIONS

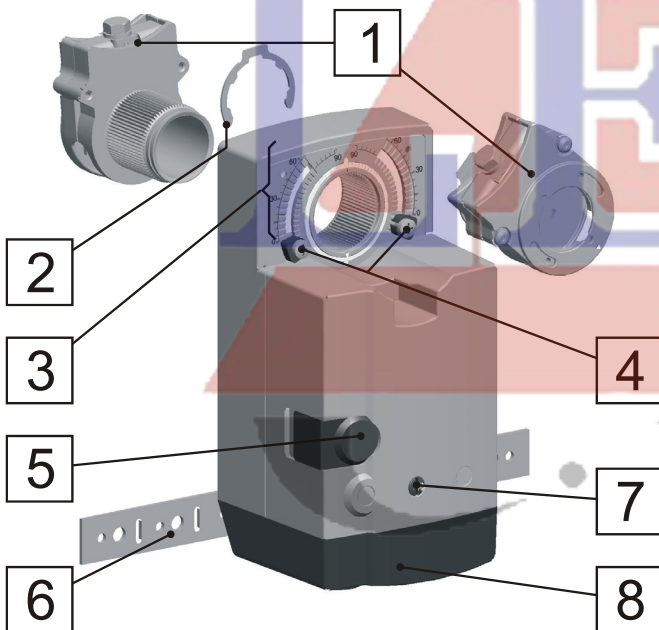

Fig. 2. Setting units and control elements

### Legend for Fig. 2:

- 1 Self-centering shaft adapter
- 2 Retainer clip
- 3 Rotational angle scales (0...90° / 90...0°)
- 4 Mechanical end limits
- 5 Declutch button
- 6 Anti-rotation bracket
- 7 Function selection switch
- 8 Access cover

## Contents of Package

The delivery package includes the actuator itself, parts 1 through 8 (see Fig. 2), the anti-rotation bracket screws, and the installation instructions.

## RUN MODES

The function selection switch (see Fig. 3) is used to place the actuator into any one of five different modes:

- 2...10 V, modulating control; floating/2-position control, CW run
- 0...10 V / Dir, modulating control; floating/2-position control, CW run
- Service/Off, actuator stops running
- 10...0 V / Rev, modulating control; floating/2-position control, CCW run
- 10...2 V, modulating control; floating/2-position control, CCW run

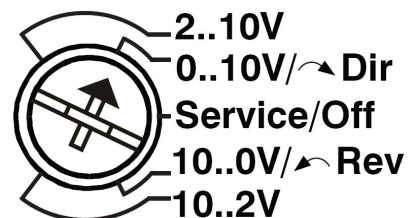

Fig. 3. Function selection switch

## Power-Off Behavior

If power is removed, the actuator retains its position.

### Service/Off

If the function selection switch is set to the "Service/Off" position, all rotary movement is cancelled, and all control signals are ignored, thus allowing the actuator to be safely manually operated.

### Floating/2-Position Run Mode

If the function selection switch has been set to one of the four positions (2...10 V, 0...10 V / Dir, 10...0 V / Rev, 10...2 V) and the actuator is wired for the floating/2-position mode (see A2 and A3), as soon as operating power is applied, the actuator will run clockwise or counterclockwise.

### Modulating Run Mode

If the function selection switch has been set to one of the four positions (2...10 V, 0...10 V / Dir, 10...0 V / Rev, 10...2 V) and the actuator is wired for the modulating mode (see A1 in section "Wiring Diagrams" on pg. 6), as soon as operating

power is applied, the actuator will run according to the control signals applied. If terminal 5 is also wired, the actuator will output the voltage feedback signal (0/2...10V) proportional to the actuator's actual position. Alternatively, if terminal 4 is wired and powered on, the actuator will override the control signal and immediately come to a position of 0% of max. stroke.

Table 1 describes the actuator behavior (stops, rotates CCW, or rotates CW) for the floating mode in relation to the control signals applied to terminals 3 and 4 and to the function selection switch setting.

Table 2 describes the actuator behavior (stops, rotates CCW, or rotates CW) for the 2-position mode in relation to the control signals applied to terminals 3 and 4 and to the function selection switch setting.

Table 3 describes the actuator behavior (stops, rotates CCW, rotates CW, runs in proportional position, or runs to 0% of max. stroke) for the modulating mode in relation to the control signals applied to terminals 3 and 4 and to the function selection switch setting.

**Table 1. Shaft adapter behavior in the floating mode**

| control signal at |            | function selection switch settings |               |               |               |          |
|-------------------|------------|------------------------------------|---------------|---------------|---------------|----------|
| terminal 3        | terminal 4 | 2...10 V                           | 0...10 V /Dir | Service / Off | 10...0 V /Rev | 10...2 V |
| open              | open       | stops                              | stops         | stops         | stops         | stops    |
| open              | 24 Vac/dc  | CCW                                | CCW           | stops         | CW            | CW       |
| 24 Vac/dc         | open       | CW                                 | CW            | stops         | CCW           | CCW      |

**Table 2. Shaft adapter behavior in the 2-position mode**

| control signal at |            | function selection switch settings |               |               |               |          |
|-------------------|------------|------------------------------------|---------------|---------------|---------------|----------|
| terminal 3        | terminal 4 | 2...10 V                           | 0...10 V /Dir | Service / Off | 10...0 V /Rev | 10...2 V |
| 24 Vac/dc         | open       | CW                                 | CW            | stops         | CCW           | CCW      |
| 24 Vac/dc         | 24 Vac/dc  | CCW                                | CCW           | stops         | CW            | CW       |

**Table 3. Shaft adapter behavior in the modulating mode**

| control signal at  |            | function selection switch settings |                |               |                 |                 |
|--|------------|------------------------------------|----------------|---------------|-----------------|-----------------|
| terminal 3   | terminal 4 | 2...10 V                           | 0...10 V /Dir  | Service / Off | 0...10 V /Rev   | 10...2 V        |
| open   | open       | --                                 | --             | stop          | --              | --              |
|  | 24 Vac/dc  | 0% (left-most)                     | 0% (left-most) | stop          | 0%(right-most)  | 0% (right-most) |
| < min. control signal plus 0.24V   | open       | --                                 | --             | stop          | --              | --              |
|  | 24 Vac/dc  | 0% (left-most)                     | 0% (left-most) | stop          | 0% (right-most) | 0% (right-most) |
| between min. control signal plus 0.24V and max. control signal minus 0.24V | open       | proportional                       | proportional   | stop          | proportional    | proportional    |
|  | 24 Vac/dc  | 0% (left-most)                     | 0% (left-most) | stop          | 0% (right-most) | 0% (right-most) |
| > max. control signal minus 0.24V  | open       | --                                 | --             | stop          | --              | --              |
|  | 24 Vac/dc  | 0% (left-most)                     | 0% (left-most) | stop          | 0% (right-most) | 0% (right-most) |

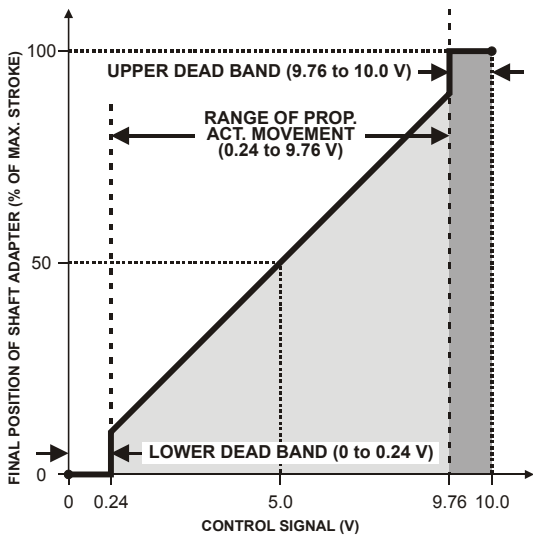

Fig. 4. Final actuator position in dependence upon control signal (func. selection switch set to)

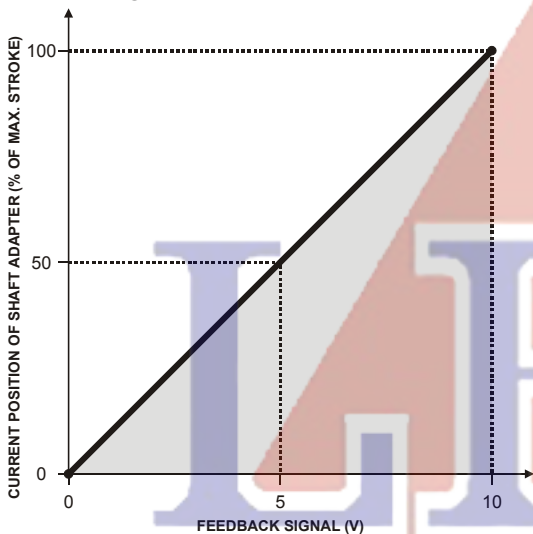

Fig. 5. Feedback signal in dependence upon current position of actuator (func. selection switch set to 0...10 V)

**Adaption**

In adaption, the actuator re-maps its feedback and control signals in accordance with repositioned mechanical end limits (see Fig. 6) and thus recognizes their new positions.

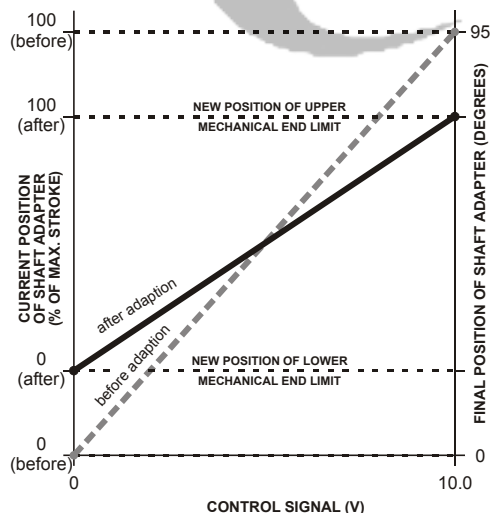

Fig. 6. Adaption (func. selection switch set to 0...10 V)

Adaption will be carried out only when:

- The actuator is wired in modulating mode (see A1 in section “Wiring Diagrams” on pg. 6).
- The control signal’s value rises up into the upper dead band (i.e., to more than the max. control signal minus 0.14V) or drops down into the lower dead band (i.e., to less than the min. control signal plus 0.14V), and if the shaft adapter can remain at the respective (upper or lower) mechanical end limit at least 3 seconds – the actuator will then recognize the new position automatically, and auto-adaption will be carried out (see Fig. 4).

**Sleep Mode**

When actuator reaches end stop or any obstacles blocking its running, it will fall into sleep mode automatically. Actuator will periodically start up and try to resume running, which will save energy significantly through whole service life.

**Overriding**

An override is a condition in which a 24 V signal is applied to terminal 4 of an actuator in the modulating mode, thus causing the actuator to ignore the control signal at terminal 3, whereupon it will instead move to a position of 0% of its maximum stroke. It would be the left-most side [0/2...10V mode] or right-most side [10...0/2 V mode] (see Table 3).

**Feedback**

If correspondingly wired (see A1 in section “Wiring Diagrams” on pg. 6), the actuator provides, via terminal 5, a feedback signal (0/2...10V) proportional to the actual position of the actuator (see Fig. 5).

**Dip Switches**

The actuator is equipped with two dip switches (only switch 1 is selectable) accessible after removing the access cover (see Fig. 7).

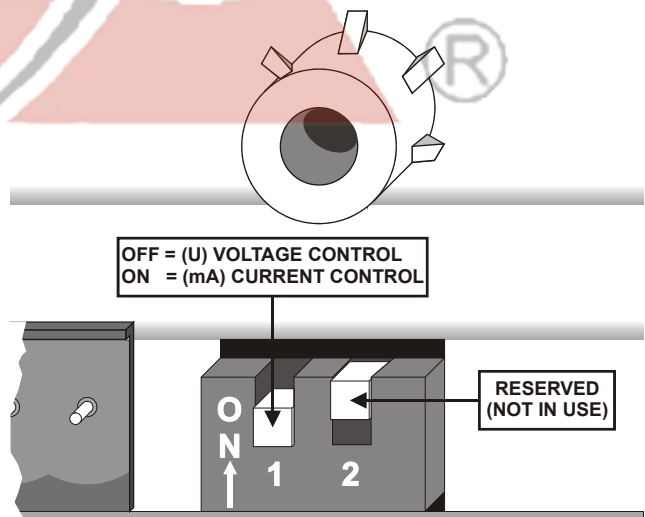

Fig. 7. Dip switches (view with PCB at bottom)

**Voltage/Current Control Signal Selection Dip Switch**

In its default shipping position, the voltage/current control signal dip switch (see Fig. 7) is set to **OFF** (= voltage control), as shown in Fig. 7. Setting it to **ON** results in 4...20 mA current control.

## Position Indication

The hub adapter indicates the rotation angle position by means of the rotational angle scales (0...90° / 90...0°).

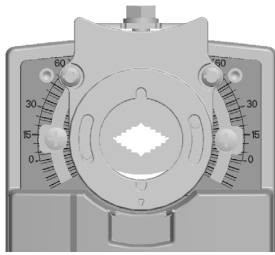

Fig. 8. Position indication

## Manual Adjustment



### IMPORTANT

In order to prevent equipment damage, you must remove power set the rotation direction switch to the "Service/Off" before manual adjustment.

After removing power or setting the rotation direction switch to the "Service/Off" position, the gear train can be disengaged using the declutch button, permitting the actuator shaft to be manually rotated to any position. The feedback signal will then follow the new position.

## Limitation of Rotation Stroke

Two mechanical end limits (adjustable in 5° increments) are provided to limit the angle of rotation as desired (see Fig. 9).

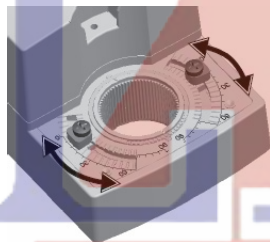

Fig. 9. Mechanical end limits

The mechanical end limits must be securely fastened in place. It is important that they properly mesh with the rotational angle scales when the screws are tightened.

## Internal End Switches

**NOTE:** Applicable to models with internal end switches, only.

The internal end switches are set to change from "common" to "normally open" at angles of 5° and 85°, respectively, from the totally counterclockwise position.

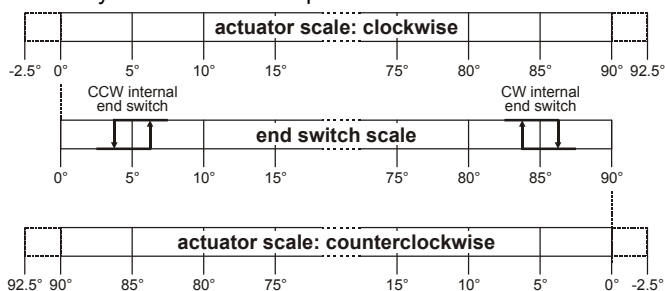

Fig. 10. Internal end switches

## INSTALLATION

These actuators are designed for single-point mounting.



### IMPORTANT

In order to prevent equipment damage, you must remove power or set the rotation direction switch to the "Service/Off" position before manual operation.

## Mounting Instructions

All information and steps are included in the installation instructions supplied with the actuator.

## Mounting Position

The actuators can be mounted in any desired orientation (no IP54 if mounted upside down; see Fig. 11). Choose an orientation permitting easy access to the actuator's cables and controls.

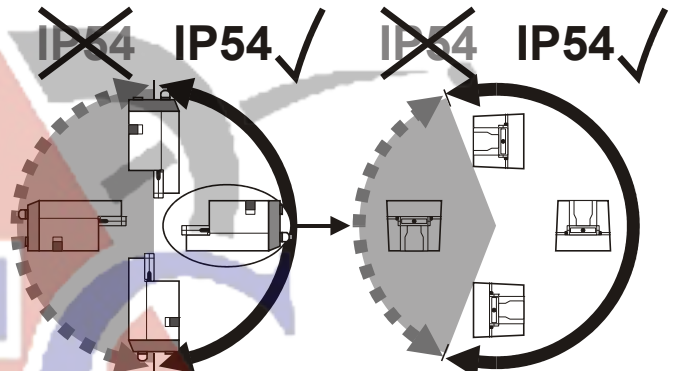

Fig. 11. Mounting for IP54

## Mounting Bracket and Screws

If the actuator is to be mounted directly on a damper shaft, use the mounting bracket and screws included in the delivery package.

## Self-Centering Shaft Adapter

The self-centering shaft adapter can be used for shafts having various diameters (10...27 mm [3/8...1-1/16"]) and shapes (square or round).

In the case of short shafts, the shaft adapter may be reversed and mounted on the duct side.

## Stroke Limitation with Mechanical End Limits

The mechanical end limits enable the stroke to be limited from 0...90° in increments of 5°.

## Wiring

### Connecting to the Power Supply

In order to comply with protection class II, the power source of 24 V actuators must be reliably separated from the network power supply circuits as per DIN VDE 0106, part 101.

**Wiring Diagrams**

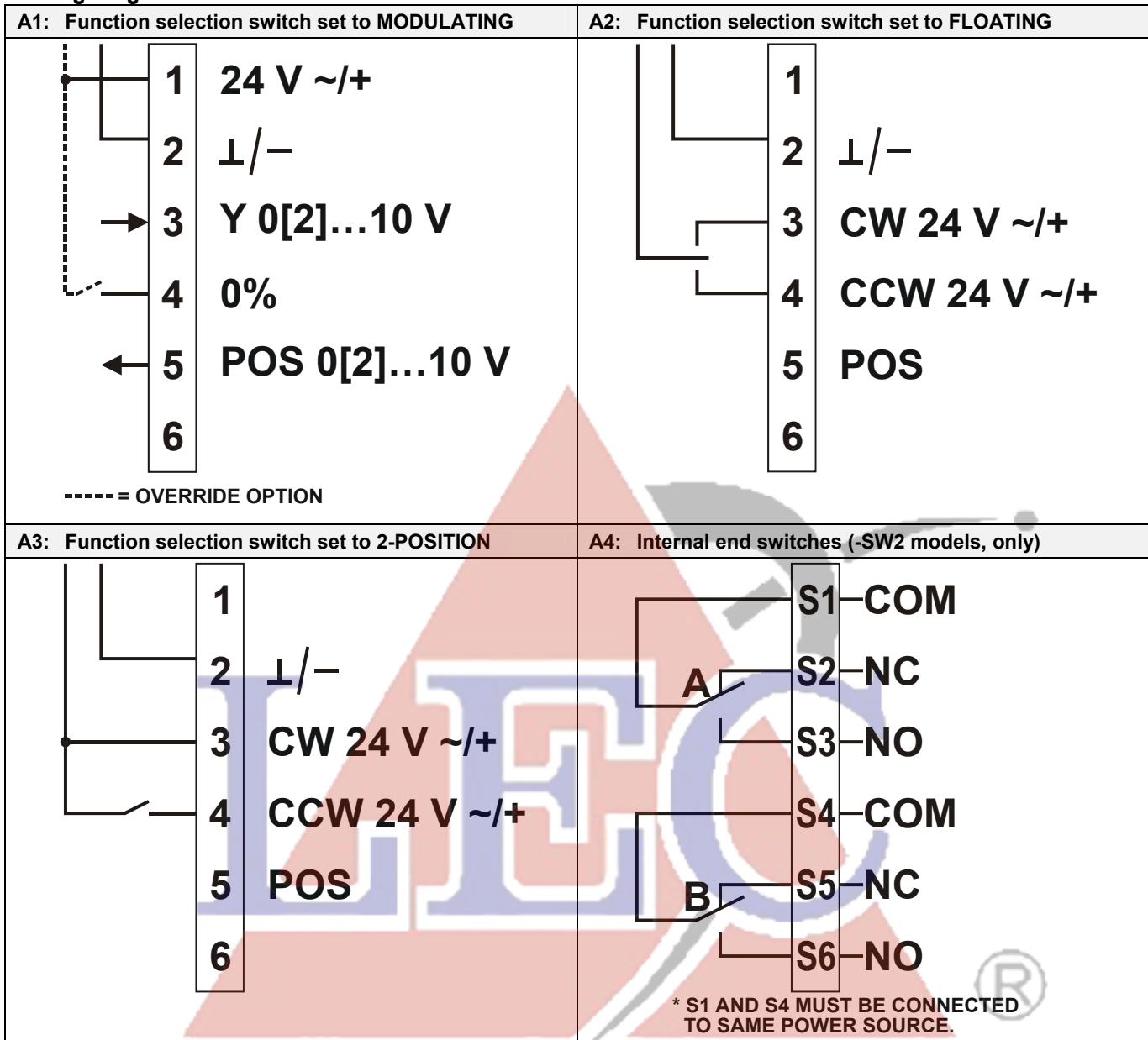

The two tables below summarize the information presented in the preceding wiring diagrams.

| terminal | function selection switch setting |                           |                           |
|----------|-----------------------------------|---------------------------|---------------------------|
|          | modulating                        | floating                  | 2-position                |
| 1        | 24 V ~/+ (power)                  | unused                    | unused                    |
| 2        | common +/-                        | common +/-                | common +/-                |
| 3        | 0[2]...10 V (control)             | 24 V ~/+ (control signal) | 24V ~/+ (control signal)  |
| 4        | 24 V ~/+ (override)               | 24 V ~/+ (control signal) | 24 V ~/+ (control signal) |
| 5        | 0[2]...10 V (feedback)            | unused                    | unused                    |

| connecting cable   | terminal       | description |                 |
|--|----------------|-------------|-----------------|
| end switches<br>(models with internal<br>switches, only) | CCW (left) 5°  | S1          | common          |
|  |                | S2          | normally closed |
|  |                | S3          | normally open   |
|  | CW (right) 85° | S4          | common          |
|  |                | S5          | normally closed |
|  |                | S6          | normally open   |

### Access Cover

To facilitate wiring the actuator to the controller, the access cover can be detached from the actuator.



## IMPORTANT

Remove power before detaching the access cover. Once the access cover has been removed, please take care to avoid damaging any of the parts now accessible.

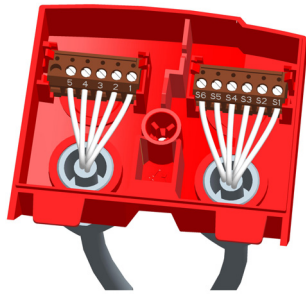

Fig. 12. Access cover (models with internal end switches)

Depending upon the model, the access cover may have one or two terminal strips, including a layout with a description for each of the terminals.

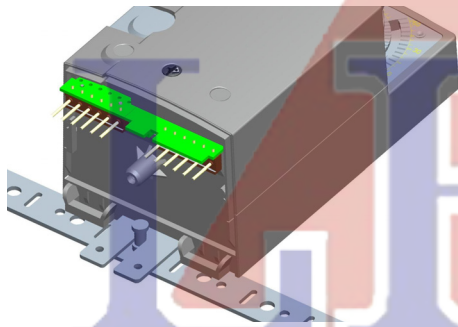

Fig. 12. Actuator with access cover removed (models with internal end switches)

## OPTIONAL ACCESSORIES

The following optional accessories are available.

### Auxiliary Switch Kit

Order no.: SW2

The auxiliary switches are field-installable parts providing two SPDT freely-adjustable switches.

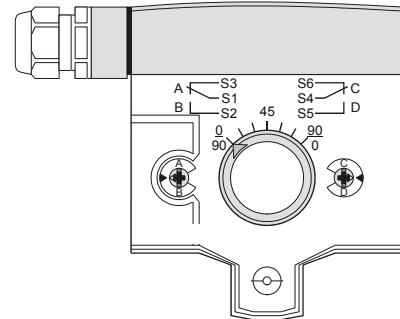

## SPARE PARTS

### Spare Parts Kit

Order no.: A7209.2071

The spare parts kit contains the following items:

- Anti-rotation bracket and screws
- Access cover screw
- Plastic protective cap for protection standard IP54
- Mechanical end limit screw and retainer

### Anti-Rotation Bracket Kit

Order no.: A7209.2073

The anti-rotation bracket kit can be ordered separately.

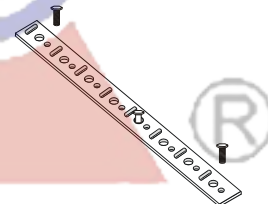

## DIMENSIONS

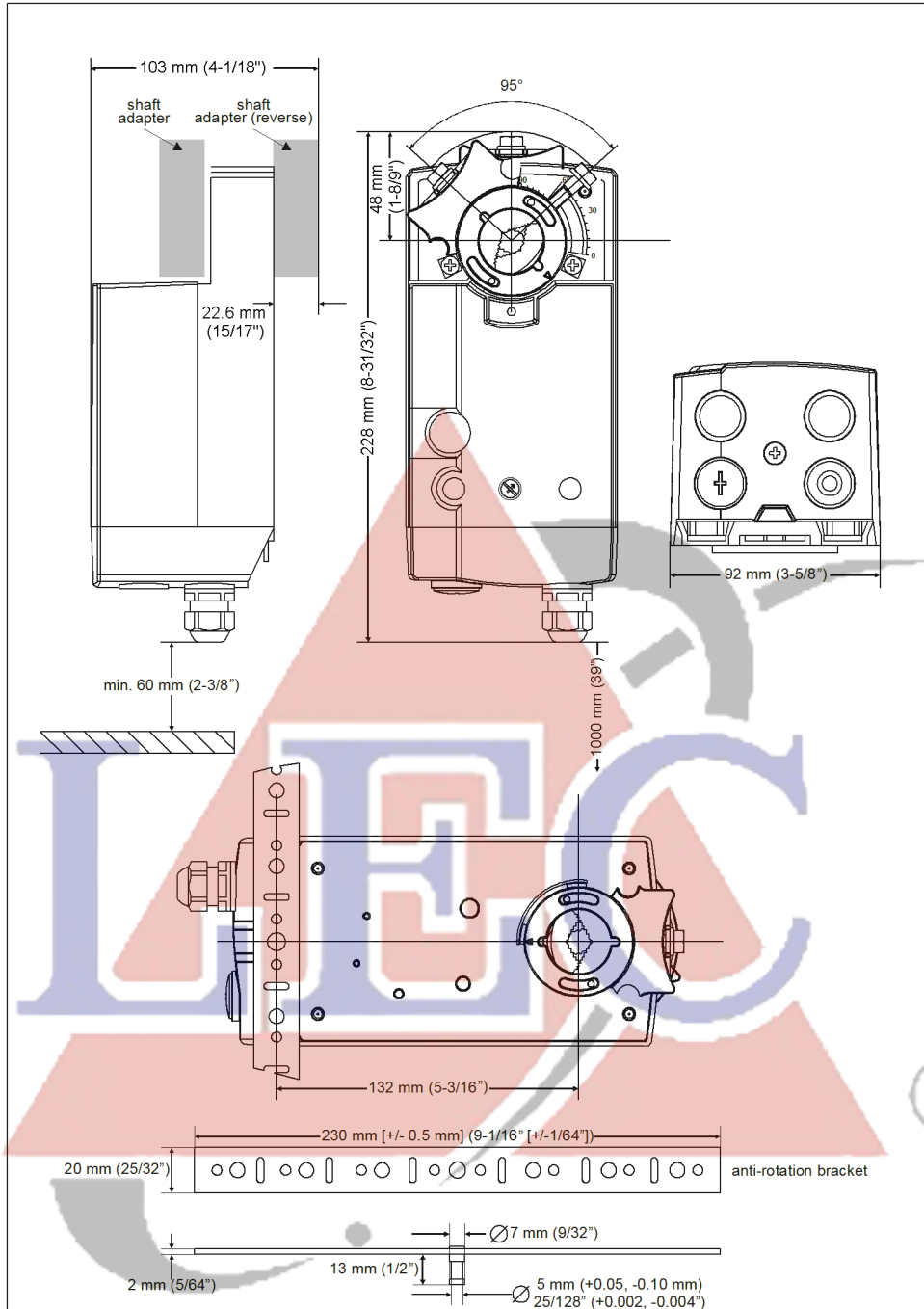

**Honeywell**

Manufactured for and on behalf of the Environmental and Combustion Controls Division of Honeywell Technologies Sàrl, Rolle, Z.A. La Pièce 16, Switzerland by its Authorized Representative:

**Automation and Control Solutions**  
 Honeywell GmbH  
 Böblinger Strasse 17  
 71101 Schönaich / Germany  
 Phone: (49) 7031 63701  
 Fax: (49) 7031 637493  
<http://ecc.emea.honeywell.com>

Subject to change without notice. Printed in Germany

EN0B-0341GE51 R0511