

VC series

BALANCED HYDRONIC VALVES 2-WAY AND 3-WAY

PRODUCT HANDBOOK

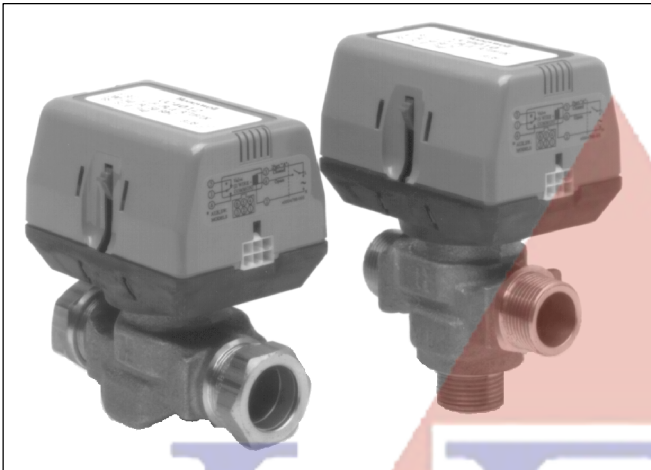

APPLICATION

The VC series balanced hydronic valves allow greater control of hot and/or cold water flow.

The VC series balanced hydronic valves are designed for both domestic boiler heating and domestic cooling applications.



Contents



	page
General	
Description	2
Series overview	3
Technical	
Construction and operation	4
Specifications	6
Dimensions	8
Valve selection chart	9
Installation and operation	
Installation data	10
Adjustment and service data	12
Various	
Quality assurance statement	13
Approvals and standards	14
Ordering information	15
Standard product examples	16
Fitting for 1/2" and 15 mm valves	17
Fitting for 3/4" and 22 mm valves	19
Fitting for 1" and 28 mm valves	20
Accessories	21

DESCRIPTION

The VC series 2-position hydronic valves are used in domestic and small commercial applications to control the flow of hot and/or cold water. They consist of an actuator, valve and a cartridge assembly.

2-way valves are designed for ON-OFF "zone" control of domestic systems.

3-way valves can be piped for either diverting or mixing valve applications in domestic central heating and/or cooling systems. Both versions can be used to control individual fan coil, baseboard radiator or convector applications.

Depending on the model selected they can be controlled by a low or line voltage SPST  or SPDT  controller, such as a room thermostat, aquastat or flow switch.

The VC series hydronic valves are designed to take advantage of sinusoidal valve actuator travel and therefore operate silently and without water hammer. Through internal logic the actuator only takes power while driving the valve to the commanded position.

The actuator head is removable without affecting the integrity of the water system. All actuator versions are interchangeable with any valve body, offering the highest flexibility for boiler production line assembly and maintenance.

The valve piston construction allows for port sealing that is independent of the differential pressure across the valve. Flow through the 2-way valve can be in either direction, so the ports are not designated.

3-way valves are suitable for both diverting water from AB to A or to B and from A or B to AB.



FEATURES

- 2-way or 3-way body
- Wide variety of pipe connections including:
 - ISO 7-1 (BSP, PI)
 - BSP.T
 - NPT
 - Sweat
 - Compression
 - Flare
- Control by a low or line voltage SPST or SPDT control
- 24 Vac, 100 ... 130 Vac or 200 ... 240 Vac actuators available
- SPDT auxiliary switch available
- Quick connect electrical connections or 1000 mm leads
- Minimal actuator power consumption
- Double insulated actuator
- Pressure differential up to 4 bar
- 1 ... 95 °C fluid temperature
- 0 ... 65 °C ambient temperature
- Quick and easy replacement of moving parts
- Actuator head installation does not require draining of the system.

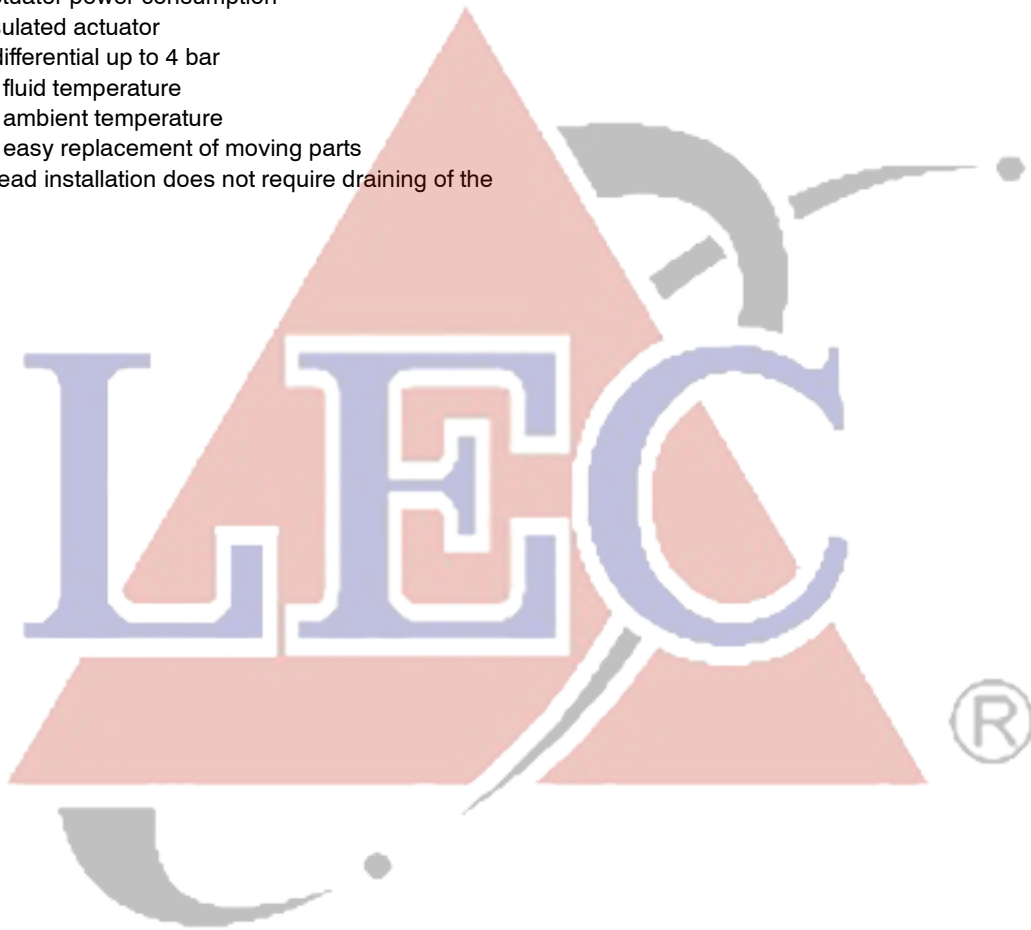

CONSTRUCTION AND OPERATION

All moving and sealing parts of the valve are constructed in the cartridge assembly.

The ports are sealed with "O"-rings on the outer surface of the piston.

When the valve stem is driven down to open port A the water will flow through the hollow piston to the other port.

In case of a 3-way valve with the piston driven down port B is sealed, allowing flow between port AB and port A. With the stem up the flow is between port AB and port B.

The VC series hydronic valves offer a variety of versions of pipe connections to suit the different applications.

The valve pressure loss characteristic is dependent on the pipe connection/dimensions

For the actual valve rating please refer to the specification section.

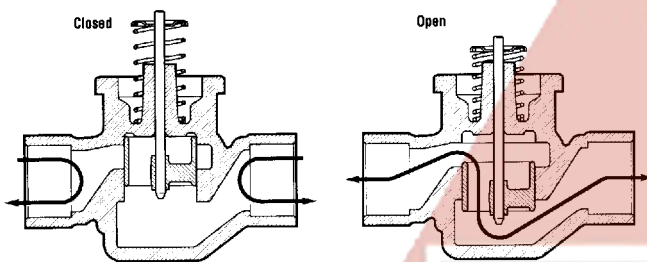

Fig. 1.

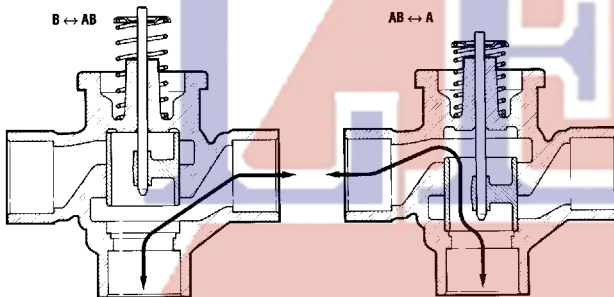

Fig. 2.

2-way valve

2-way valve with an SPDT (3-wire) actuator

On a call for heat, the NO controller contacts close and the valve opens. When the valve is fully open, the cam closes switch SW₁ and opens switch SW₂.

When the need for heat is satisfied the NC controller contacts close, energizing the valve through SW₁ and closing the valve.

When the valve is fully closed the cam closes SW₂ and opens SW₁. The valve is ready for the next call for heat.

2-way valve with an SPST (2-wire and common) actuator

On a call for heat, the controller contacts close, RLY₁ is energized making the NO contacts in switch SW₃ causing the valve to open.

When the valve reaches the fully open position the cam closes switch SW₁ and opens the switch SW₂.

When the need for heat is satisfied, the controller contacts open, RLY₁ is de-energized and the valve motor driven through SW₁ and the NC contacts of SW₃.

When the valve reaches fully closed position, the cam closes SW₂ and opens SW₁. The valve is ready for the next call for heat.

For both types of actuator a power failure will leave the valve at the position it was interrupted.

When power is restored, the valve will respond to controller demand.

3-way diverter valve

3-way diverter valve with an SPDT (3-wire) actuator

On a call for heat, the NO controller contacts close, the valve closes port B and opens port A.

When port A is in the fully open position, the cam closes limit switch SW₁ and opens limit switch SW₂.

When the need for heat is satisfied the NC controller contacts close, energizing the valve through SW₁ causing port A to close.

When port A is fully closed the cam closes SW₂ and opens SW₁. The valve is ready for the next call for heat.

3-way diverter valve with an SPST (2-wire and common) actuator

On a call for heat, the controller contacts close, RLY₁ is energized making the NO contacts in switch SW₃, causing port B to close and port A to open.

When port A reaches the fully open position the cam closes switch SW₁ and opens the switch SW₂.

When the need for heat is satisfied, the controller contacts open. RLY₁ is de-energized making the NC contacts in SW₃ and port A is driven closed through SW₁ and the NC contacts of SW₃.

When port A is in the fully closed position, the cam closes SW₂ and opens SW₁. The valve is ready for the next call for heat.

For both types of actuator a power failure will leave the valve at the position it was when interrupted.

When power is restored, the valve will respond to controller demand.

Wiring

Fig. 3. and 4. show wiring connections for SPDT and SPST controllers on either 2-way valves or 3-way valves.

Port A "open" and "closed" denotes valve open and closed for 2-way, and AB-B open and AB-B open for 3-way valves respectively.

On a 2-way valve:

Port A open denotes valve open

On a 3-way valve:

Port A open denotes flow through AB-A

Port A closed denotes flow through AB-B

For mixed low/line voltage, the cable assembly version recommended.

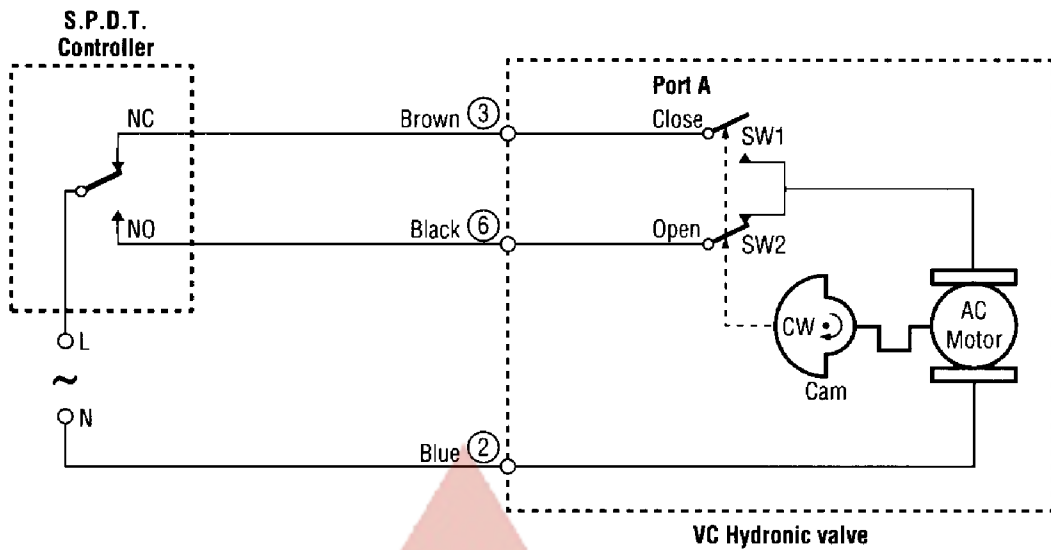

Fig. 3. Logic sequence diagram with 3 wire actuator for SPDT controller

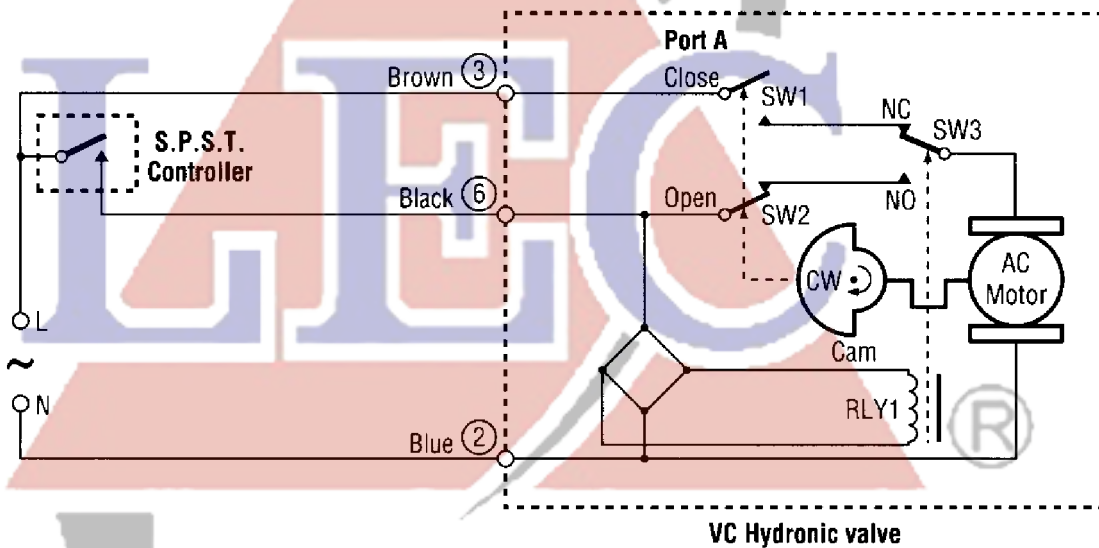

Fig. 4. Logic sequence diagram with 2 wire + common actuator for SPST controller

SPECIFICATIONS

Voltage	Colour-coded label
24 V, 50/60 Hz	Blue
100 ... 130 V, 50/60 Hz	Black
200 ... 240 V, 50/60 Hz	Red

Power consumption

6 Watt maximum at nominal voltages (during valve position change only)
 6 VA for transformer and wiring
 Maximum power time: 15%

End switch rating

2.2 A inductive from 5 ... 120 Vac
 1.0 A inductive above 120 ... 277 Vac
 Minimum dc switching capability: 0.05A 24 Vdc

Nominal timing

Valve opens in 6 seconds @ 60 Hz (20% longer @ 50 Hz)

Electrical termination

- Molex™ (header# 39-30-1060)
 Requires mating connector receptacle/housing # 39-01-2060
 Contacts: Mini-Fit 5556 series
- With integral 1000 mm (39") leadwire cable

Pipe fitting sizes

See table 1.

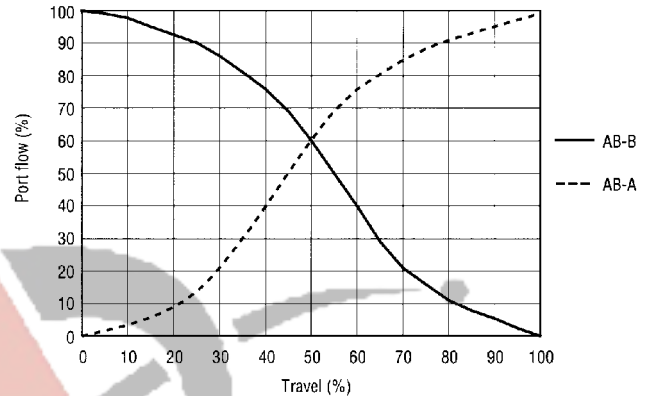

Fig. 5. 3-way valve diverting flow characteristic at constant pressure on port AB

Table 1. Pipe fitting sizes

Pipe fitting sizes	3/8"	1/2"	3/4"	1"	15 mm	22 mm	28 mm	Note: N - not threaded I - internally threaded E - externally threaded
Flare	E	E	-	-	-	-	-	
Inverted flare	-	I	-	-	-	-	-	
Sweat	-	N	N	N	-	-	-	
BSPP	-	I	E, I	E, I	-	-	-	
BSPT	-	I	I	-	-	-	-	
NPT	-	-	I	I	-	-	-	
Compression fitting	-	-	-	-	I	E	E	

Terminal	Action	Wire colour
1	Com*	Orange
2	Neutral	Blue
3	Closed**	Brown
4	NO*	Grey
5	NC*	White
6	Open**	Black

* Terminals 1, 4 and 5 are only connected if an auxiliary switch is used.
 NO, NC refers to port A closed position

** Refers to port A (closed or open)

NOTE: For mixed voltages (low/line voltage) the cable assembly version is recommended

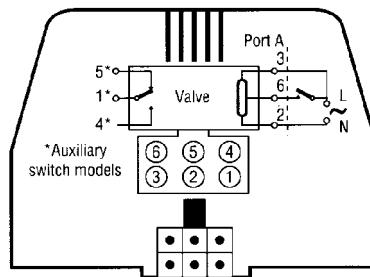

Molex™ version

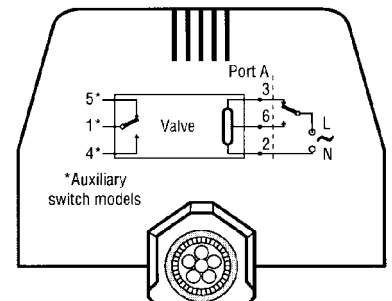

Lead wire cable

Fig. 6. Wiring terminal colour coding

Table 2. Wiring connections and valve movements

Actuator type	Connections		2-way valve movement	3-way valve movement
	Cable model	Molex™ model		
3-wire (for SPDT controller)	Blue & brown energized Black de-energized	Pin #2 & 3 energized Pin #6 de -energized	Closes	A port closes
	Blue & black energized Brown de-energized	Pin #2 & 6 energized Pin #3 de -energized	Opens	B port closes
2-wire + common (for SPST controller)	Blue & brown energized Brown and black open	Pin #2 & 3 energized Pin #3 and 6 open	Closes	A port closes
	Blue & brown energized Brown and black closed	Pin #2 & 3 energized Pin #3 and 6 closed	Opens	B port closes

Ambient temperature

0 ... 65 °C

Fluid temperature

1 ... 95 °C (120 °C short duration peak)

Shipping storage temperature

-40 ... 65 °C

Pressure rating

Static: 20 bar

Burst: 100 bar

Maximum operating pressure differential

4 bar

Flow rating

Dependent upon body configuration (see fig. 5., 7. and 8.)

Flow rate **Q** m³/h to be calculated as:

$$Q = K_v \times \sqrt{\Delta p} \text{ (bar)}$$

Pressure loss Δp (bar) to be calculated as:

$$\Delta p = \left(\frac{Q}{K_v}\right)^2$$

Flow

2-way

Flow can be in either direction

Valve is closed without the actuator mounted

3-way

Flow can be diverting (AB to A or B) or mixing (A or B to AB).

Port A is closed without the actuator mounted

Valve material

Body: bronze

Cartridge: Ryton™ (polyphenylene sulphide)

Noryl™ (polyphenylene oxide)

”O”-ring seals: EPDM rubber

Stem: stainless steel

Actuator cover: Noryl™ (94V-0)

Actuator base: Ryton™ (94V-0)

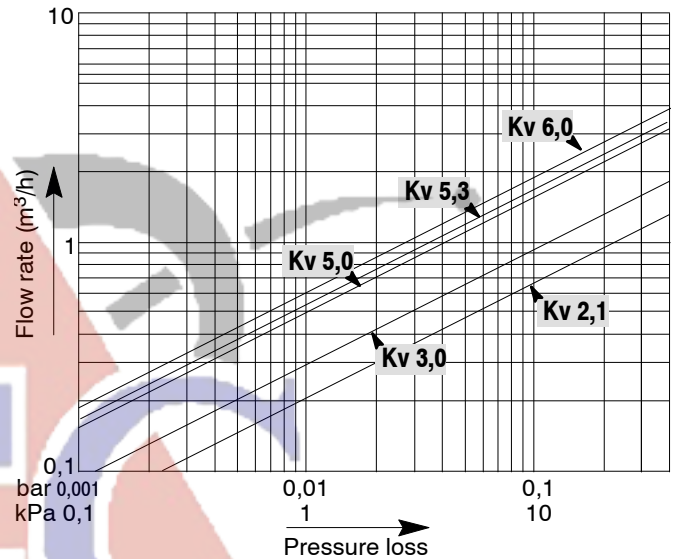

Fig. 7. Valve pressure loss characteristic for 2-way valves

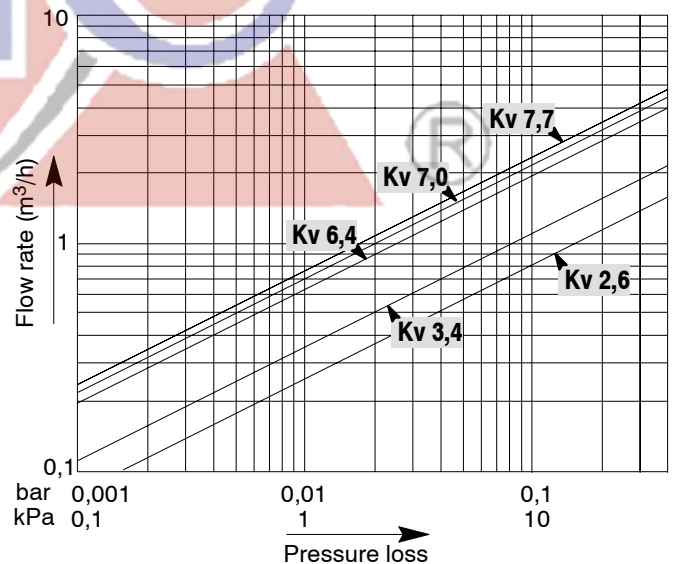

Fig. 8. Valve pressure loss characteristic for 3-way valves

DIMENSIONS (NOMINAL)

Pipe fitting	2-way valve			3-way valve		
	Dim. C mm	Dim. D mm	Nom. flow rating - Kv	Dim. C mm	Dim. E mm	Nom. flow rating - Kv
1/2" Sweat	98	111	3.0	98	136	3.6
1/2" BSPT (internal thread)	98	111	3.0	98	136	3.4
3/8" flare (no adapter)	98	111	2.1	98	136	2.6
1/2" flare (no adapter)	98	111	2.9	98	136	3.4
1/2" inverted flare (no adapter)	98	111	3.1	98	136	3.6
1/2" BSPP/15 mm (internal thread)	98	111	3.0	98	136	3.4
22 mm compression fitting*	112	113	5.3	112	140	7.1
3/4" BSPP (external thread)	94	113	5.3	94	130	6.9
3/4" BSPP (internal thread)	94	113	5.3	94	130	7.0
3/4" BSPT (internal thread)	94	113	5.3	94	130	7.0
3/4" NPT (internal thread)	94	113	5.4	94	130	7.4
3/4" Sweat	94	113	5.0	94	132	6.4
28 mm compression fitting*	116	113	6.0	116	147	7.7
1" BSPP (internal thread)	94	113	6.0	94	136	7.7
1" BSPP (external thread)	94	113	6.0	94	136	7.7
1" NPT (internal thread)	94	113	6.0	94	136	7.7
1" Sweat	94	113	6.0	94	136	7.7

* Includes compression nuts and olives

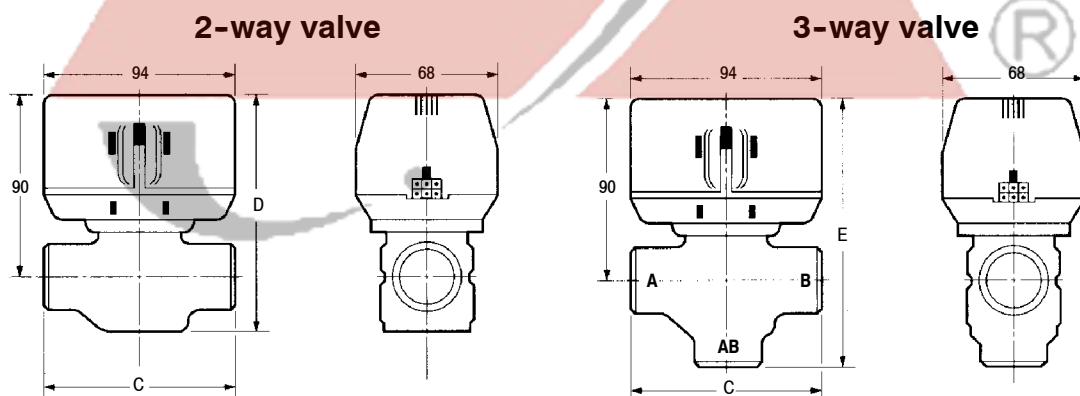

Fig. 9. Valve dimensions

VALVE SELECTION CHART

"A" ACTUATORS	"B" BODY	"C" CARTRIDGE	CUSTOMER SPECIAL	PACKAGING		
Description Nominal timing @ 50 Hz: 7 seconds	Description Designation	Kv Designation	Description Designation	Description Designation		
24 V (50 ... 60 Hz) 3 wire for SPDT stat. - with Molex™ connector - with 1000 mm cable 3 wire for SPDT stat.(w/SPDT aux. sw.) - with Molex™ connector - with 1000 mm cable 2 wire + com. for SPST stat. - with Molex™ connector - with 1000 mm cable 2 wire + com. for SPST stat. (w/SPDT aux. sw) - with Molex™ connector - with 1000 mm cable	2010 2011 2610 2611	AA AB AC AD AE AF	00 Standard Designation 01 ... 99 Customer special assigned by Honeywell	Unit pack (10 per overpack) Egg crate (20) (20 actuators per pack) (10 body/cartridge(s) per pack) Note: Order in multiples of 20 actuators & 20 valves for egg crate pack.		
	100 ... 130 V (50 ... 60 Hz) 3 wire for SPDT stat. - with Molex™ connector - with 1000 mm cable 3 wire for SPDT stat. (w/SPDT aux. sw.) - with Molex™ connector - with 1000 mm cable 2 wire + com. for SPST stat. - with Molex™ connector - with 1000 mm cable 2 wire + com. for SPST stat. (w/SPDT aux. sw.) - with Molex™ connector - with 1000 mm cable	8010 8011 8610 8611	AG AH AJ AK AL AM AN AP AQ AR AS AT			
		200 ... 240 V (50 ... 60 Hz) 3 wire for SPDT stat. - with Molex™ connector - with 1000 mm cable 3 wire for SPDT stat.(w/SPDT aux. sw.) - with Molex™ connector - with 1000 mm cable 2 wire + com. for SPST stat. - with Molex™ connector - with 1000 mm cable 2 wire + com. for SPST stat. (w/SPDT aux. sw.) - with Molex™ connector - with 1000 mm cable	6010 6011 6610 6611 4010 4011 4610 4611 6012 6013 6612 6613 4012 4013 4612 4613	2-way valves 3.0 3.2 2.1 2.3 3.1 3.0 5.3 5.3 5.3 5.3 5.4 5.0 6.0 6.0 6.0 6.0 6.0 6.0 3-way valves 3.6 2.6 3.4 3.6 3.4 7.1 6.9 7.0 7.0 7.4 6.4 7.7 3.4 7.7 7.7 7.7 7.7 7.7		
			<p>Example: A "VC 4612 MM 6000" valve has a 200/240 V, 50/60 Hz, 6 second nominal timing actuator (with a SPDT auxiliary switch) for operation by a SPST thermostat suitable for Molex™ connection. The valve has a 3-way body with 28 mm compression fittings rated at 7.7 Kv & 60 psi differential. Shipped in unit pack.</p>			

INSTALLATION

IMPORTANT

Take care that installer is a trained experienced service person.

When installing this product read these instructions carefully.

Failure to follow them could damage the product or cause a hazardous condition.

Check the ratings given in the instructions and on the product to make sure it is suitable for your application.

Always conduct a thorough checkout after installation.



CAUTION

Switch off power supply before making electrical connections to prevent electrical shock and equipment damage.

It is advisable to remove the actuator head from the valve body for ease of installation.

Fit the actuator head in the most convenient position for wiring.

On sweat fitted valves, the cartridge is shipped loose or is removed to avoid being damaged during the solder operation.

On 24 Volt systems, never short circuit the valve coil terminals as this may burn out the heat anticipator in the thermostat.

To remove the actuator head 25 mm clearance is needed above the actuator.

Plumbing (see fig. 10.)

The valve may be plumbed in any angle but preferably not with the actuator head below the horizontal level of the valve body. Make sure there is enough room around the actuator head for servicing or replacement.

When used to form a part of a central heating system, do not locate it where it will block the system vent, cold feed or any bypass when the valve is closed

Mount the valve directly in the tube or pipe. Do not grip actuator head while making and tightening plumbing connections. Either hold valve body in your hand or attach adjustable spanner across the hexagonal or flat faces on the valve body.

Compression models

For compression fitted models, tighten the compression nuts enough to make a watertight seal.

Take care not to overtighten.

Maximum torque limit is 33 ft-lb for the 22 mm compression fitting and 48 ft-lb for the 28 mm compression fitting.

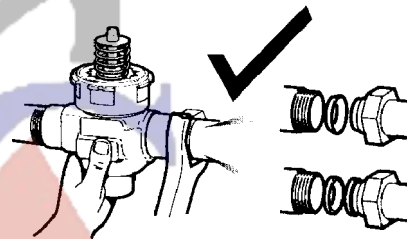
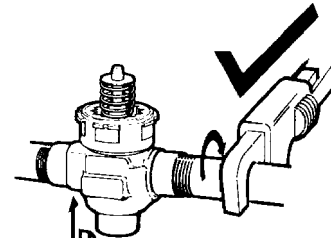
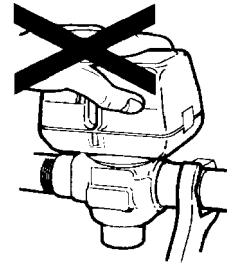

Fig. 10. Plumbing

Sweat models

On sweat fitted valves, the cartridge is shipped loose to avoid being damaged during the solder operation.

- Remove valve actuator from body and solder the connecting pipes in accordance with normal soldering practices.
- After soldering and valve has cooled, remove cartridge assembly from plastic bag, insert into the valve body and tighten down with enclosed wrench until it bottoms out. Do not overtighten (maximum torque is 40 ft-lb). The top surface of the cartridge will be flush with the top edge of the body casting.
- Replace valve actuator.

To install a replacement actuator head

IMPORTANT

Installation of a new actuator head does not require draining the system providing the valve body and cartridge assembly remain in the pipe line.

Disconnect power supply before servicing to avoid electrical shock or equipment damage.

Disconnect leadwires to actuator head, or depress tab on Molex™ connector and remove.

Where appropriate, label wires for rewiring.

- The actuator head is automatically latched to the valve (see fig. 11.) To remove lift up on the latch mechanism located directly below the red manual open lever.
- Press the actuator head down towards the valve body with moderate hand force and turn counter-clockwise by $\frac{1}{8}$ turn (45 degrees) simultaneously.
- Lift the actuator head off the valve body.

NOTE: The actuator can also be installed at right angles to the valve body but in this position the latch mechanism is not engaged.

- Install the new actuator head by reversing the process.
- Reconnect leadwires or Molex™ connector.
- Restore power.

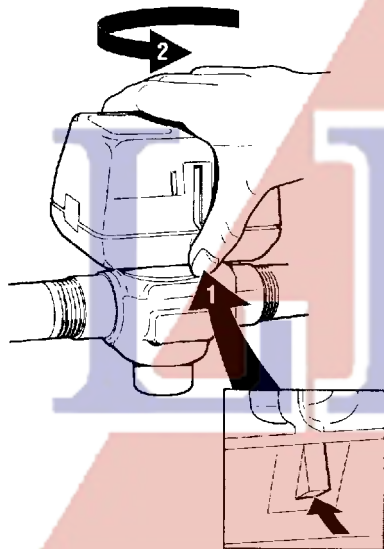

Fig. 11. Latch mechanism

ADJUSTMENT, CHECKOUT AND SERVICE

Manual opener

The manual opener can be manipulated when in the up position.

The motorized valve can be opened by firmly pushing the red manual lever down to midway and in (only possible if the actuator is in the upper position).

This holds all ports in the open position and with auxiliary switch models the NO switch is closed.

Ports A and B of 3-way valves are opened.

This "manual open" position may be used for filling, venting or draining the system or for opening the valve in case of power failure. The valve can be restored manually to the closed position by depressing the red manual lever lightly and then pulling it out.

The valve actuator returns to the automatic position when power is restored.

Checkout

- Raise the setpoint of the thermostat above room temperature to initiate a call for heat.
Valve position indicator should move downward to the open position.
- For all auxiliary switch models, monitor the control devices.
2-way valve:
check that the valve opens, the auxiliary switch (if present) closes and at the end of the opening stroke the circuit to the circulator or another valve is made.
3-way valve:
check that port A opens, port B closes, the auxiliary switch (if present) operates and at the end of the opening stroke the circuit to the circulator or another valve is made.
- Lower the set point of the thermostat below room temperature.
- Observe the control devices.
2-way valve:
check that the valve closes and all auxiliary equipment stops.
3-way valve:
check that port A closes and all auxiliary equipment stops.

Service



WARNING

The VC series hydronic valves should be serviced by trained, experienced service personnel.

- If the valve is leaking, drain system or isolate valve from the system.
- Check to see if the cartridge needs to be replaced.
- If the gear train of the motor is damaged, replace the actuator assembly.

NOTE: The VC series hydronic valves are designed and tested for silent operation in properly designed and installed systems.

However, water noises may occur as a result of excessive water velocity.

Piping noises may occur in high temperature (over 100 °C) systems with insufficient water pressure.

QUALITY ASSURANCE STATEMENT

The quality system is described in Honeywell Limited's Quality Manual and supporting operational procedures and instructions.

The quality system is approved by Quality Management Institute (accredited by the Standards Council of Canada and RvC) against certificate 001082 and is reviewed annually.

The quality organisation is responsible for defining, maintaining, improving and verification of the quality systems in the field of design, production process and field quality service.

Each production operation has manufacturing instructions containing work procedures, set-up information, quality standards and quality checks.

All products are tested prior to shipping.

Assembly inspection is conducted by the assembly workers.

All inspections (incoming and assembly) are performed by trained personnel and according inspection procedures.



STANDARDS AND APPROVALS

Approvals

The VC series balanced hydronic valves 200 ... 240 V and 24 V versions meet the Low Voltage Directive 73/23/EEC (EN 60730-1 and -2 -8) and EMC Directive 89/336/EEC for incorporation in household electrical applications according to EN 60335 series.



ORDERING INFORMATION

Before ordering please determine the following:

- The body type:
2-way or 3-way. See **Valve selection chart** page 9
- The actuator voltage:
24, 100 ... 130 or 200 ... 240 Vac. See **Valve selection chart** page 9
- The pipe fitting size:
to do this first determine the flow rating (Kv) required. Refer to Dimensions page 6 to select the pipe fitting that is applicable.

Then, contact your Honeywell account manager who will assist you in determining the order specification number.

Order from:

- Your nearest Honeywell branch office.
- Your local Honeywell agent or wholesaler.

NOTE: Most models of valves and replacement components will be available under "TRADELINE" label. Ask your wholesaler for details.

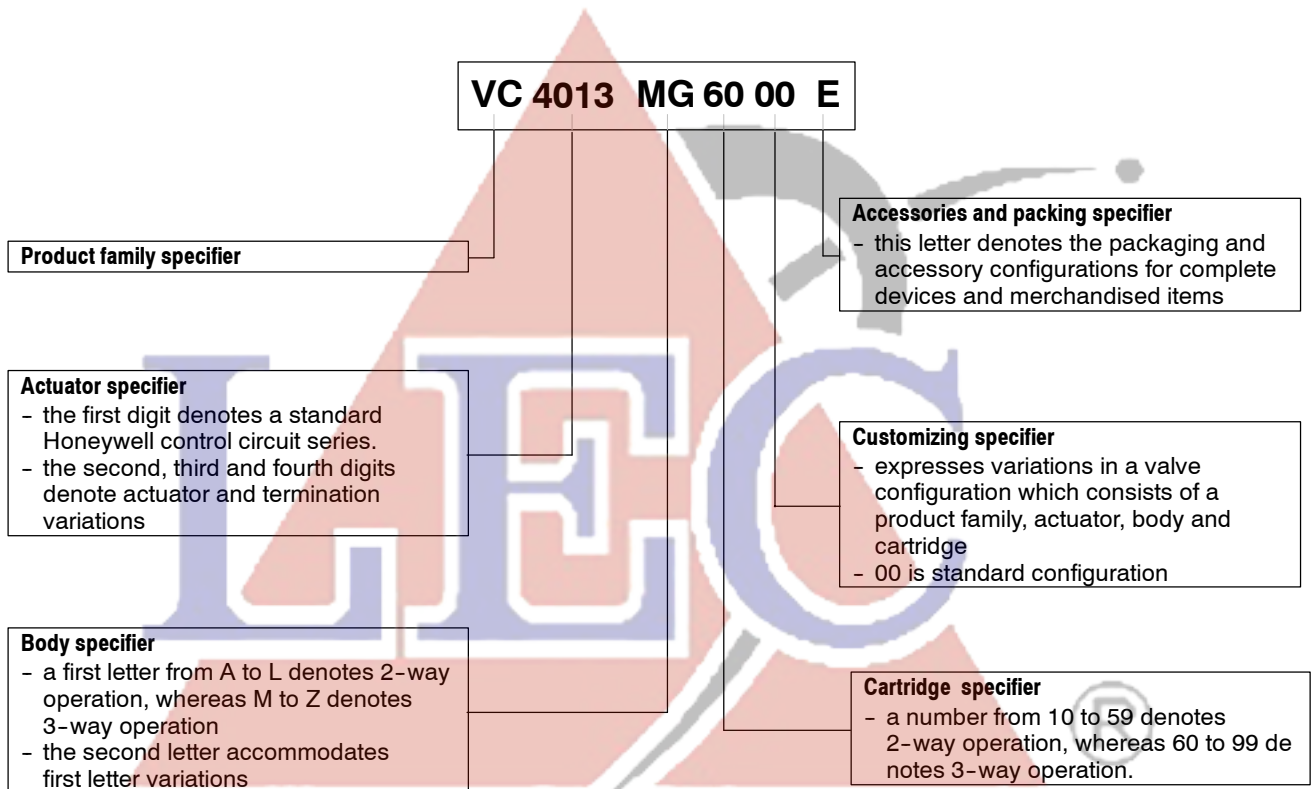

Fig. 12. Model number chart

STANDARD PRODUCT EXAMPLES

NOTE: The letter "Z" denotes the absence of a component

VC2010MG 6000

- VC2010 actuator packed with a MG6000 body

VC2010ZZ 00E

- Egg crate with 20 actuators type 2010

VC Z MG6000E

- Egg crate with 10 bodies type MG6000

VC2010ZZ00

- Actuator only

VC ZZ 6000

- Cartridge for 3-way valve
Minimum quantity 10 pcs

VC ZZ 1000

- Cartridge for 2-way valve
Minimum quantity 10 pcs



FITTINGS FOR 1/2" AND 15 MM VALVE FAMILY (COMMONLY USED WITH VC VALVES)

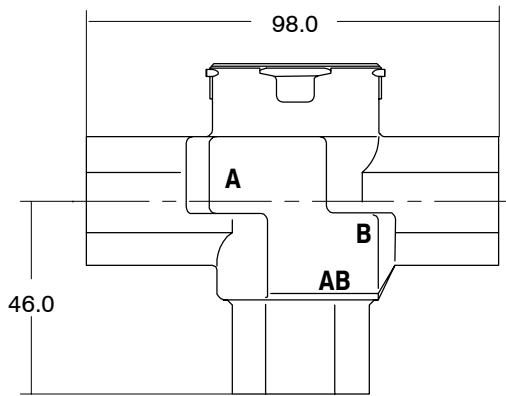

Fig. 13. Finished dimensions of 1/2" or 15 mm bronze bodies (VC valves)

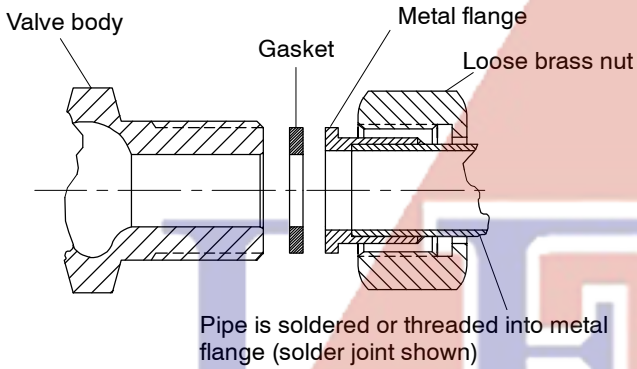
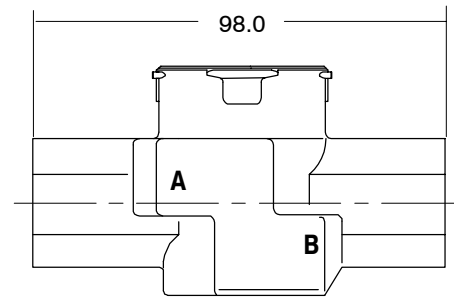

Fig. 14. 1/2" BSPP external (G 1/2 B)

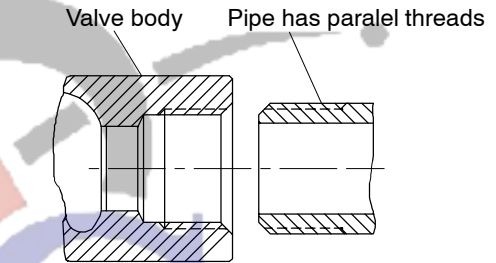
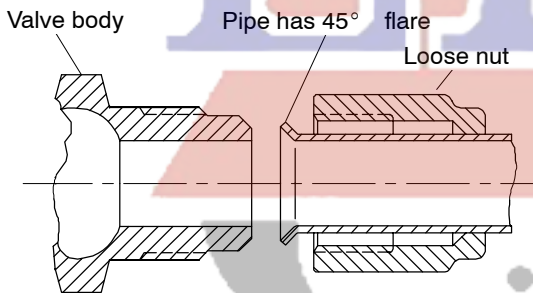

Fig. 16. 1/2" BSPP internal (Rp 1/2")



North America 1/2" pipe (5/8" outer diameter)

Fig. 15. 1/2" flare

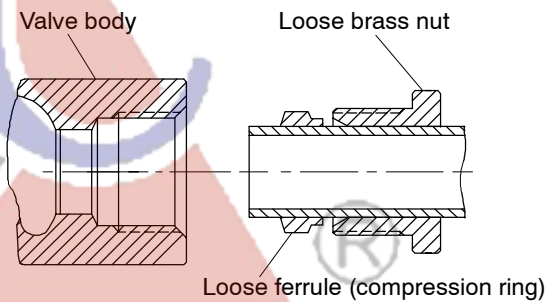
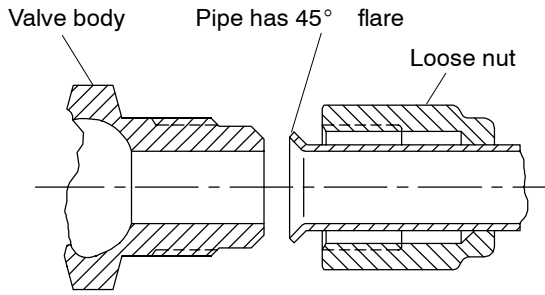
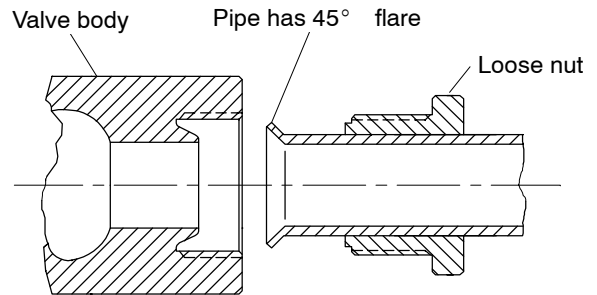

Fig. 17. 1/2" BSPP internal (Rp 1/2") using ferrule & nut for sealing 15 mm outer diameter pipe



For North America 3/8" pipe (1/2" outer diameter)

Fig. 18. 3/8" flare



For North America 1/2" pipe (5/8" outer diameter)

Fig. 20. 1/2" inverted flare

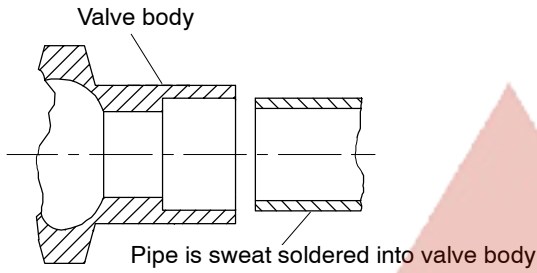

North America 1/2" pipe sweat fitting

Fig. 19. 1/2" Sweat

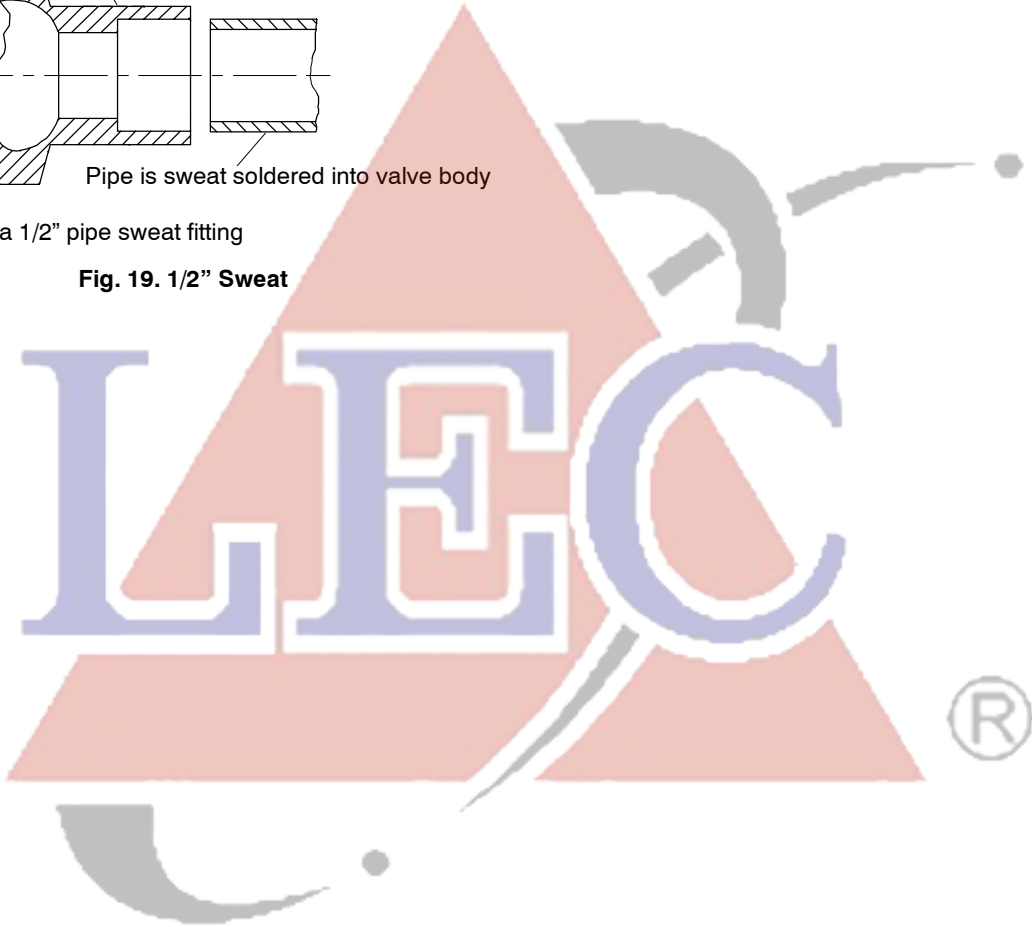

FITTINGS FOR 3/4" AND 22 MM VALVE FAMILY (COMMONLY USED WITH VC VALVES)

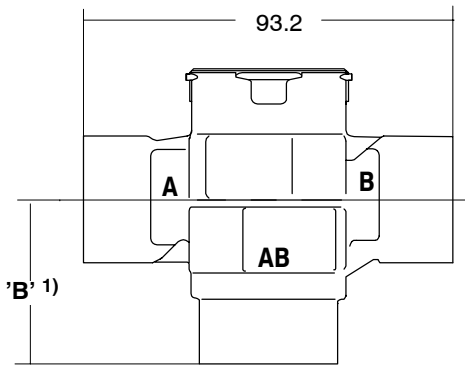
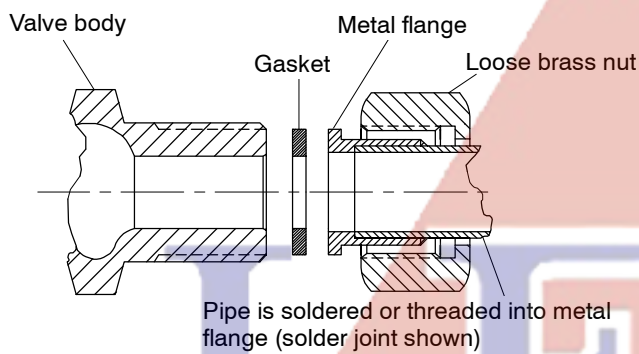
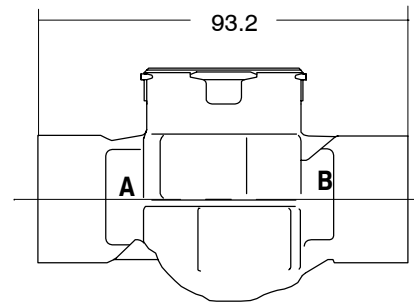

Fig. 21. Finished dimensions of 3/4" or 22 mm bronze bodies (VC valves)



1) 'B' = 39.9
Fig. 22. 3/4" BSPP external (G 3/4 B)

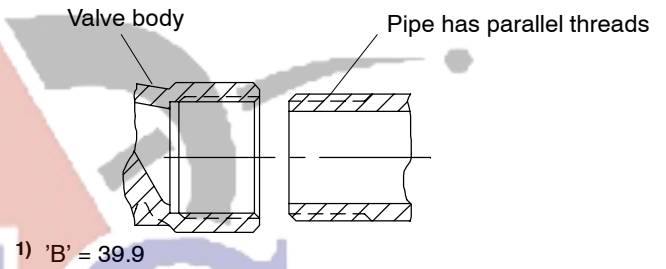
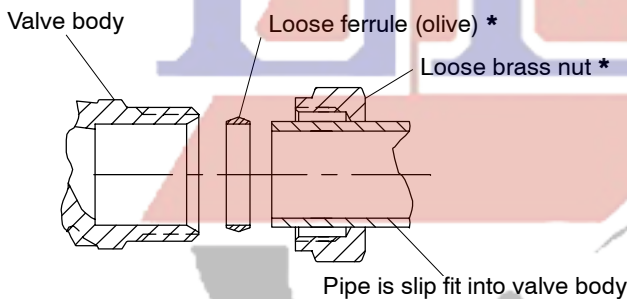

Fig. 24. 3/4" BSPP internal (Rp 3/4)



Using ferrule and nut for sealing 22 mm outerdiameter pipe.
1) 'B' = 39.9
* Compression nut and olive are supplied with the valve body.

Fig. 23. 22 mm compression (external thread)

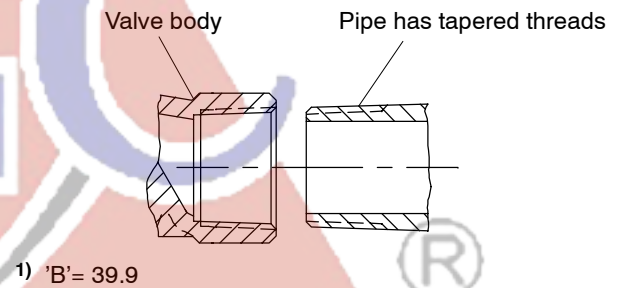
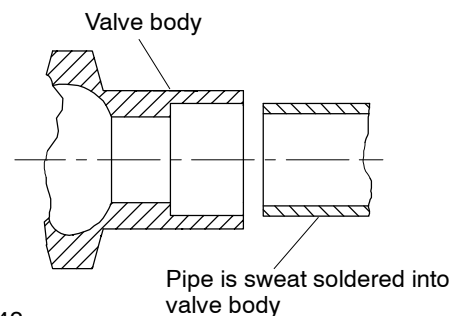

Fig. 25. 3/4" BSPT internal (Rc 3/4) or NPT internal



1) 'B' = 42
North America 3/4" pipe sweat fitting

Fig. 26. 3/4" Sweat

FITTINGS FOR 1" AND 28 MM VALVE FAMILY (COMMONLY USED WITH VC VALVES)

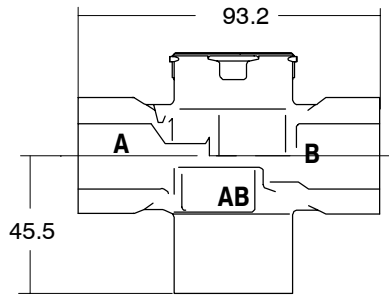

Fig. 27. Finished dimensions of 1" or 28 mm bronze bodies (VC valves)

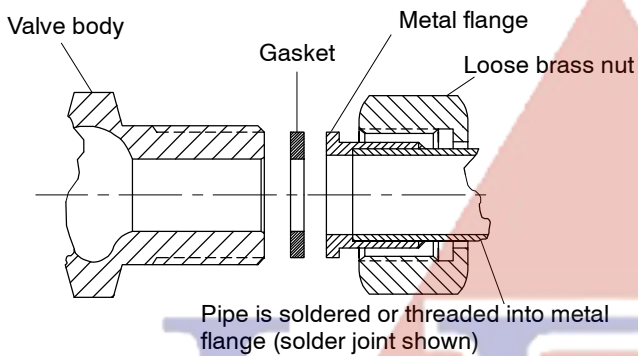
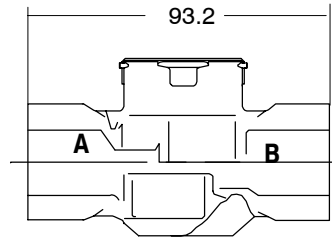

Fig. 28. 1" BSPP external (G 1 B)

Pipe is soldered or threaded into metal flange (solder joint shown)

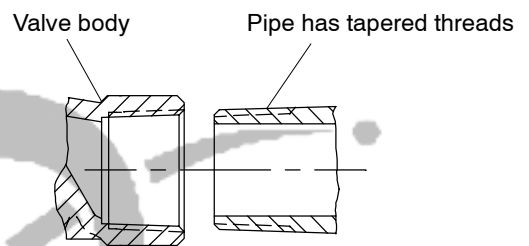

Fig. 31. 1" BSPT internal (Rc 1) or 1" NPT internal

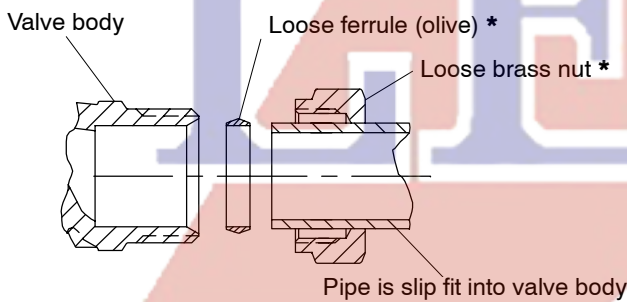

Fig. 29. 28 mm compression (external thread)

Using ferrule and nut for sealing 28 mm outerdiameter pipe.
* Compression nut and olive are supplied with the valve body.

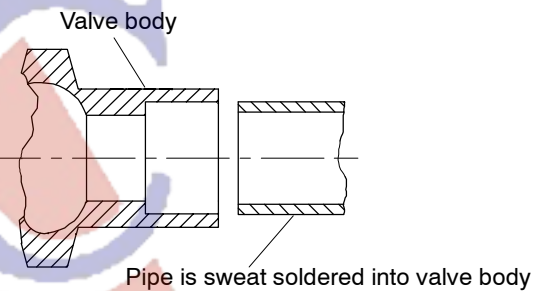

Fig. 32. 1" Sweat

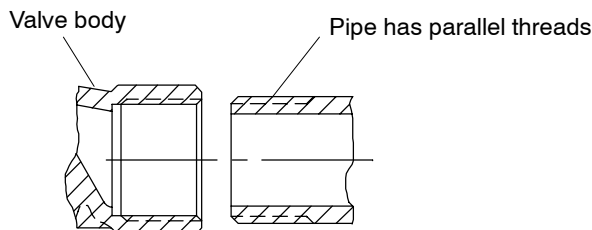

Fig. 30. 1" BSPP internal (Rp 1)

ACCESSORIES

Replacement cartridge (includes change tool)

Cartridge for 2-way valve

- order number: **VCZZ1000**
- supplied in overpacks of 10 units

Cartridge for 3-way valve

- ordernumber: **VCZZ6000**
- supplied in overpacks of 10 units

Molex™ connector with wires



CAUTION

Not to be used for line voltage or mixed low/line voltage applications.

3-wire Molex™ connector, length 5"

- ordernumber: **40.007.035-001**

6-wire Molex™ connector, length 5"

- ordernumber: **40.007.035-002**

3-wire Molex™ connector, length 1000 mm

- ordernumber: **40.007.035-005**

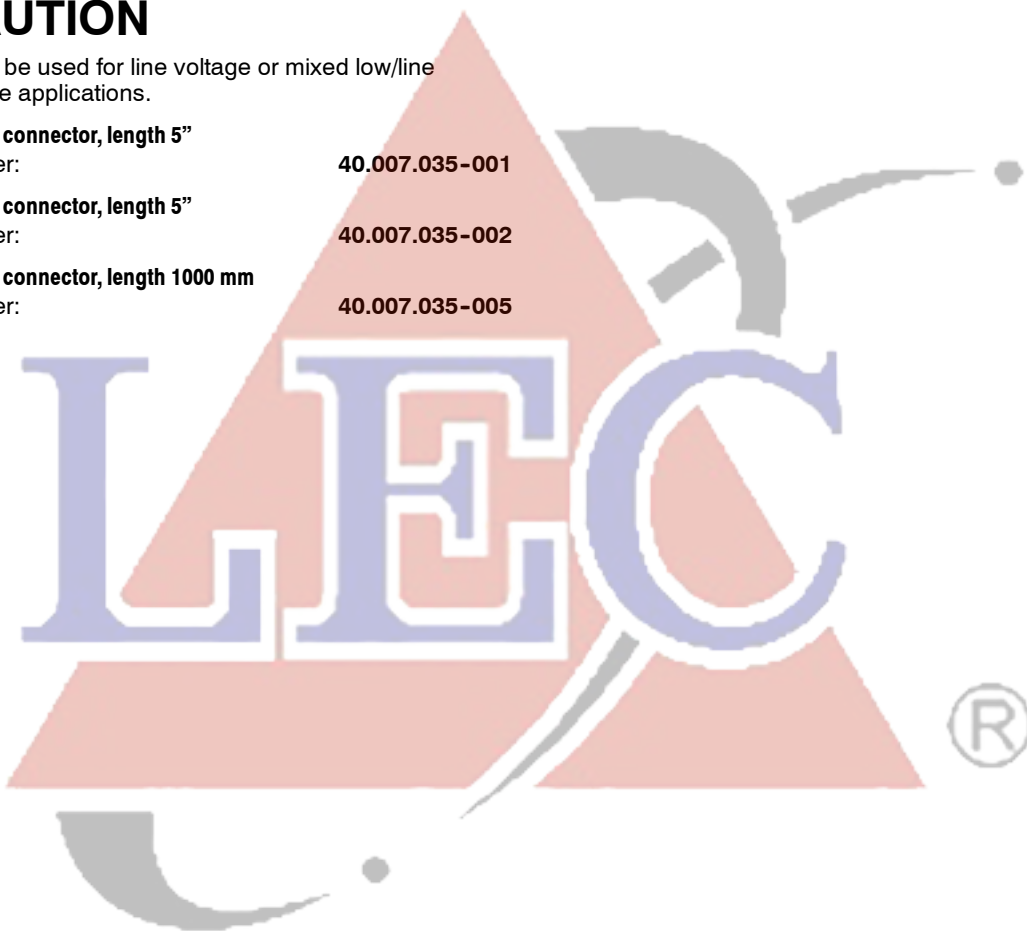

Honeywell

Home and Building Control
Combustion Controls Center Europe
Honeywell BV
Phileas Foggstraat 7
7821 AJ Emmen
The Netherlands
Tel: +31 (-)591 695911
Fax: +31 (-)591 695200
<http://europe.hbc.honeywell.com>